



# Les essentiels pour kinésithérapeutes

Tables de traitement électriques  
Fauteuil de rééducation du genou  
Presses à jambes  
Pouliethérapies

**Produit en Stock**



**ML FUSION /DESIGN KINEXO**  
zone de l'Alouette - 1 Route d'Estaires  
62136 LA COUTURE

03 21 53 82 67  
06 48 18 57 05

[www.design-kinexo.fr](http://www.design-kinexo.fr)  
[designkinexo@gmail.com](mailto:designkinexo@gmail.com)



# Table KIN10

Table avec pack cadre de commande et roulettes escamotables.

**Produit en Stock**

**Gamme classique**

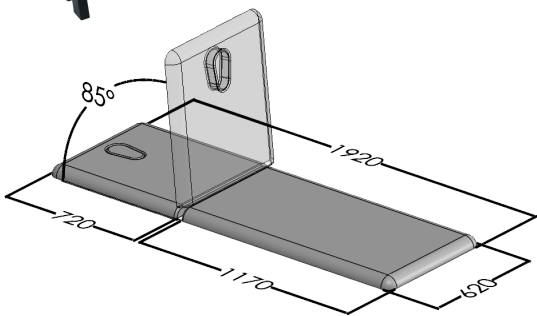

Dossier procline inclinable par vérin à gaz (de 0° à 85°)

Vérin électrique 6000 N

Commande par cadre périphérique

Patin stabilisateur réglable

Châssis gris foncé ou blanc

Sellerie l 62 cm L 192 cm (fente nasale + bouchon intégré)

Sellerie finition tendue agrafée pétrole ou cendre

Poids 88 kg Ht mini 51 cm Ht maxi 86 cm

Charge maxi supportée 140 kg

Sellerie  
Coloris en stock

Châssis  
Coloris en stock

Plus d'options  
Nous consulter



Pétrole Cendre



blanc gris foncé



Dispositif Médical



\*voir fiche technique



# Fauteuil QUAD100

Un fauteuil conçu pour des possibilités de travail de rééducation variées.

**Produit en Stock**

*L'original*

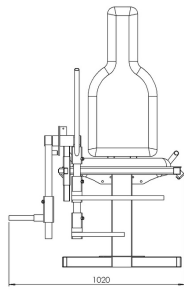

Sellerie  
Coloris en stock



Pétrole Cendre

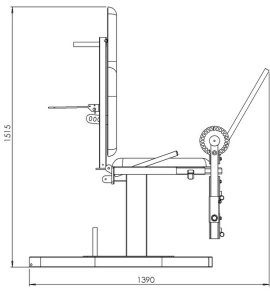

Châssis  
Coloris en stock



gris foncé

Plus d'options  
Nous consulter



\*voir fiche technique

- Caractéristiques :
- Dossier inclinable par vérin à gaz de 90° à 180°
  - Réglable en profondeur par système pendulaire
  - Compas gradué avec butées d'amplitude
  - Poignée d'aide au mouvement
  - Support poids avec disques inclus 2 x 2 kg et 3 x 1 kg
  - Sellerie tendue agrafée pétrole ou cendre
  - Châssis gris foncé
  - Plus d'options nous consulter



# Presse Frontale

Une presse à charge frontale créée pour travailler les quadriceps avec un faible encombrement.

**Produit en Stock**

Caractéristiques : L 245 cm | 72 cm H 167 cm Pds 260kg

- Réglage de l'assise en profondeur
- Plateau pieds fixe avec antidérapant
- Dossier réglable
- Charge automatique de 120 kg
- Câble acier gainé réglable
- Châssis gris foncé et sellerie tendue agrafée
- Plus d'options nous consulter



## La référence

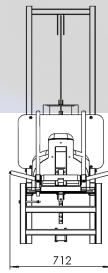
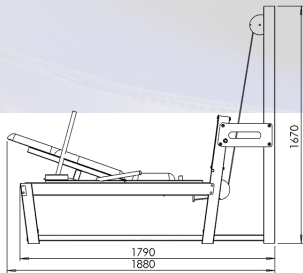

Sellerie  
Coloris en stock



Pétrole Cendre

Châssis  
Coloris en stock



gris foncé

Plus d'options  
Nous consulter



\*voir fiche technique



# Presse latérale

Une presse à charge latérale prévue pour travailler les quadriceps avec un accès direct à la colonne de charges et un encombrement réduit.

**Produit en Stock**

Caractéristiques :

L 228 cm l 100 cm H 182 cm Pds 260 kg

Réglage de l'assise en profondeur

Plateau pieds fixe avec antidérapant

Dossier réglable

Charge automatique de 120 kg

Câble acier gainé réglable

carter de protection arrière

Châssis gris foncé et sellerie tendue

Plus d'options nous consulter

**La référence**

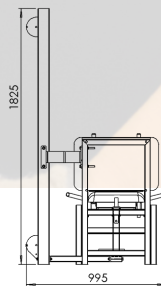
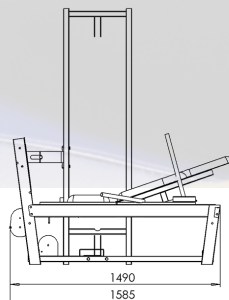
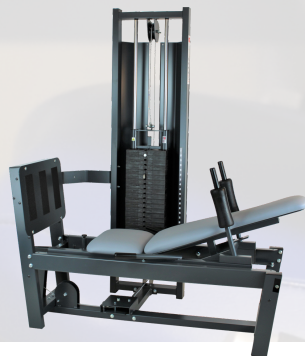

Sellerie  
Coloris en stock



Pétrole Cendre

Châssis  
Coloris en stock



gris foncé

Plus d'options  
Nous consulter



\*voir fiche technique



# Poulie Universelle DK50

**Produit  
en Stock**



Une poulie universelle conçue pour solliciter l'ensemble des muscles avec un faible encombrement (pectoraux, biceps, triceps, dorsaux, deltoïdes, abdominaux, fessiers, ...).

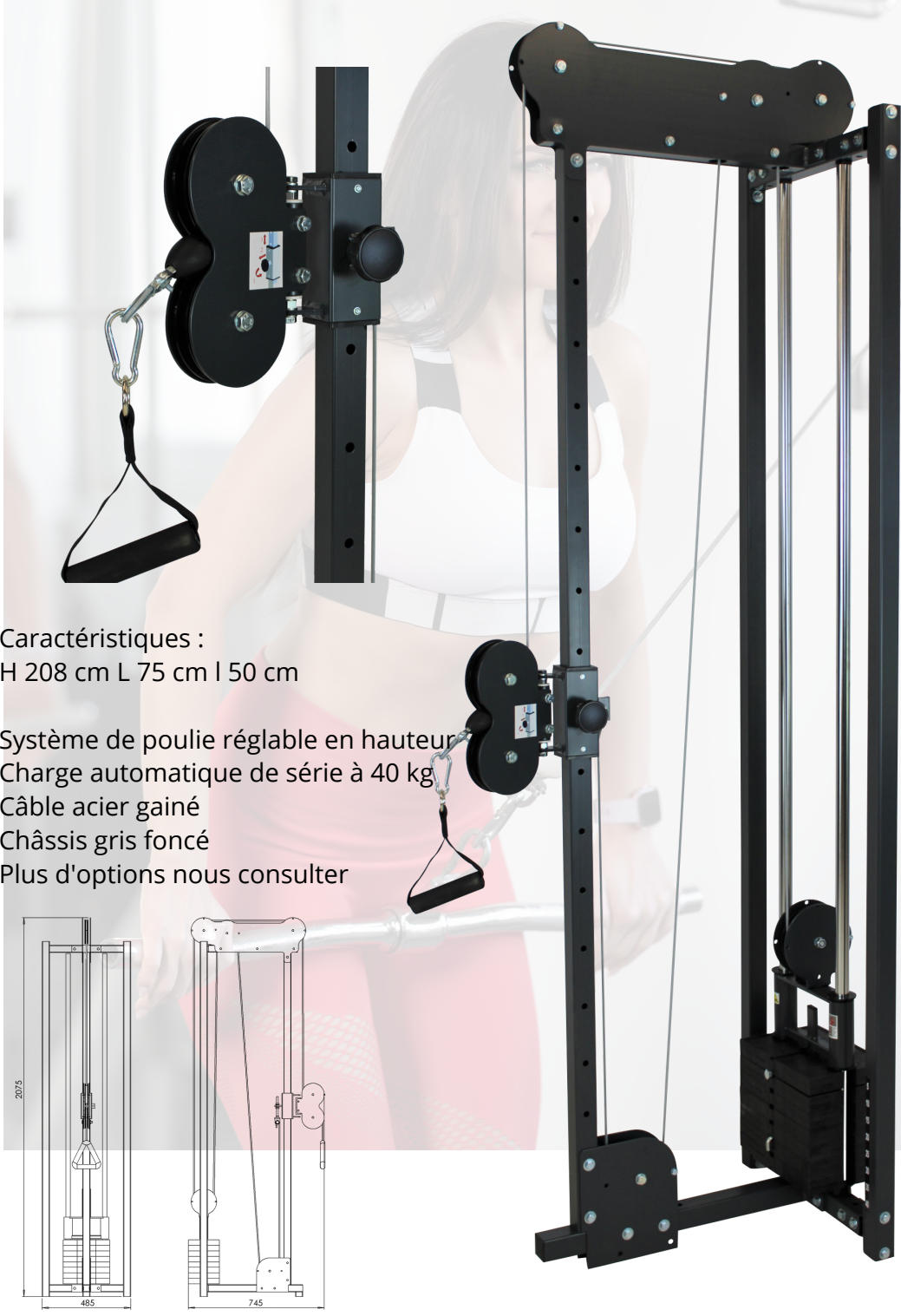

Caractéristiques :  
H 208 cm L 75 cm l 50 cm

Système de poulie réglable en hauteur  
Charge automatique de série à 40 kg  
Câble acier gainé  
Châssis gris foncé  
Plus d'options nous consulter

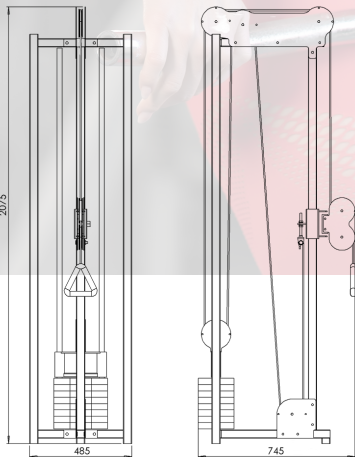

Châssis  
Coloris en stock



gris foncé

Plus d'options  
Nous consulter



\*voir fiche technique



# Poulie Universelle DK75

**Produit  
en Stock**



Une poulie universelle conçue pour solliciter l'ensemble des muscles avec un faible encombrement (pectoraux, biceps, triceps, dorsaux, deltoïdes, abdominaux, fessiers, ...).



Caractéristiques:  
H 208 cm L 75 cm I 50 cm

Système de poulie réglable en hauteur  
Charge automatique de série à 40 kg  
Câble acier gainé  
Châssis gris foncé  
Plus d'options nous consulter

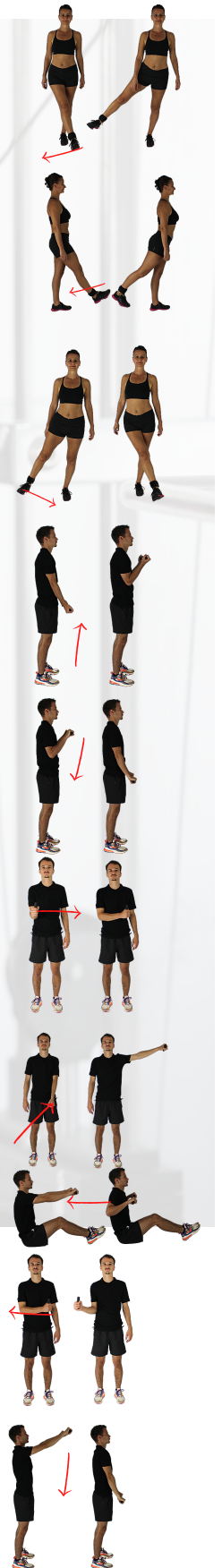
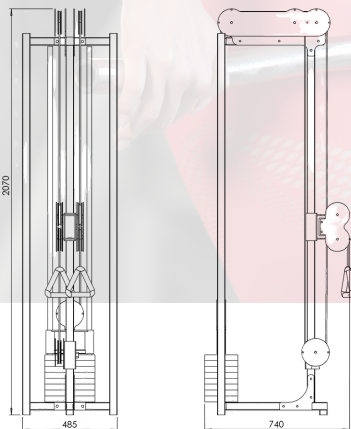

Châssis  
Coloris en stock



gris foncé

Plus d'options  
Nous consulter



\*voir fiche technique